

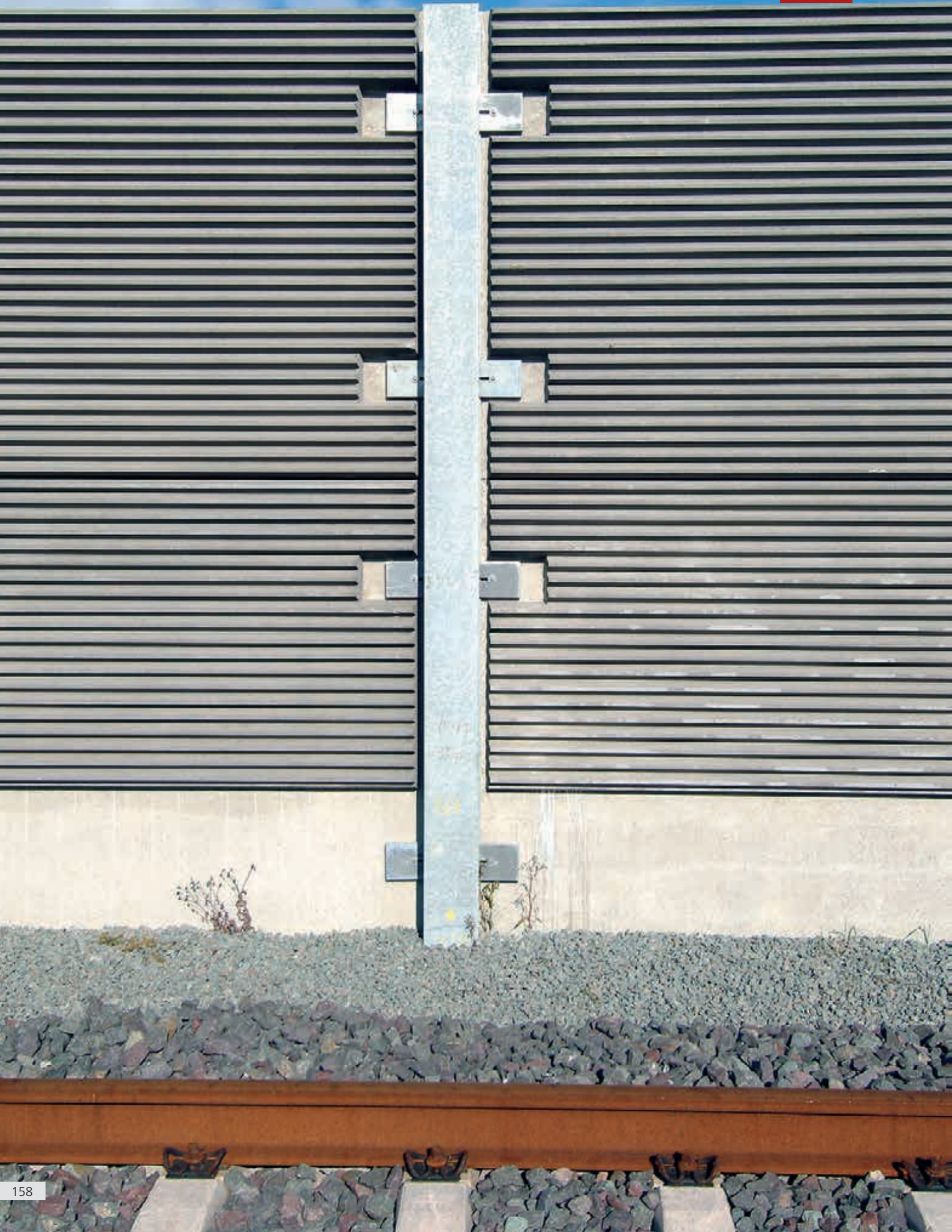

Grecados

Formliner – designed Concrete





564100 Antwerpen

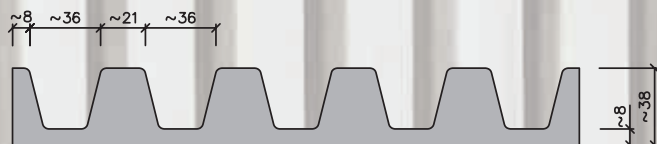

Mattengrößen | Mat sizes | Dimensiones de la estera |
Dimensions des matrices | Matafmetingen | Размерби матриц

A	mm MM	1218
B	mm MM	6000

Mattenstärke | Mat thickness | Espesor de la estera | Epaisseur des matrices
Matdikte | Толщина матриц

	mm MM	~ 38
--	---------	------

Gewicht | Weight | Peso | Poids | Gewicht | Вес

	kg/m ² kr/M ²	~ 34,0
--	---------------------------------------	--------

B
↑
A
→

565400 Ascona

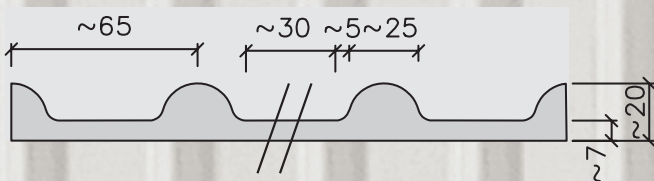

Mattengrößen | Mat sizes | Dimensiones de la estera |
Dimensions des matrices | Matafmetingen | Размеры матриц

A	mm MM	1500
B	mm MM	8500

Mattenstärke | Mat thickness | Espesor de la estera | Epaisseur des matrices
Matdikte | Толщина матриц

mm | MM ~ 20

Gewicht | Weight | Peso | Poids | Gewicht | Вес

kg/m² | kr/M² ~ 14,0

B
↑

→ A

569158 Barmbeck

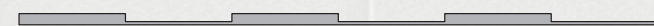
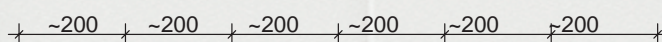

Mattengrößen | Mat sizes | Dimensiones de la estera |
Dimensions des matrices | Matafmetingen | Размери матриц

A	mm MM	1200
B	mm MM	7500

Mattenstärke | Mat thickness | Espesor de la estera | Epaisseur des matrices
Matdikte | Толщина матриц

	mm MM	~ 21
--	---------	------

Gewicht | Weight | Peso | Poids | Gewicht | Вес

	kg/m ² kr/M ²	~ 19,0
--	---------------------------------------	--------





564000 Brügge

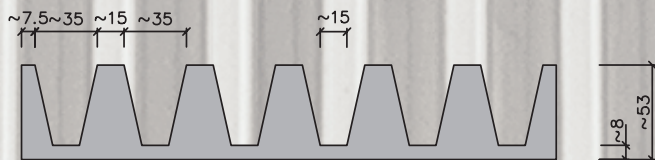

Mattengrößen | Mat sizes | Dimensiones de la estera |
Dimensiones des matrices | Matafmetingen | Размери матриц

A	mm MM	1000
B	mm MM	4500

Mattenstärke | Mat thickness | Espesor de la estera | Epaisseur des matrices
Matdikte | Толщина матриц

	mm MM	~ 53
--	---------	------

Gewicht | Weight | Peso | Poids | Gewicht | Вес

	kg/m ² kr/M ²	~ 44,0
--	---------------------------------------	--------

B
↑
A
→

563400 Brüssel



Mattengrößen | Mat sizes | Dimensiones de la estera |
Dimensions des matrices | Matafmetingen | Размеры матриц

A	mm MM	1200
B	mm MM	6000

Mattenstärke | Mat thickness | Espesor de la estera | Epaisseur des matrices
Matdikte | Толщина матриц

	mm MM	~ 40
--	---------	------

Gewicht | Weight | Peso | Poids | Gewicht | Вес

	kg/m ² kr/M ²	~ 27,0
--	---------------------------------------	--------

B
↑

→ A

565800 Budapest



Mattengrößen | Mat sizes | Dimensiones de la estera |
Dimensions des matrices | Matafmetingen | Размери матриц

A	mm MM	1000
B	mm MM	4300

Mattenstärke | Mat thickness | Espesor de la estera | Epaisseur des matrices
Matdikte | Толщина матриц

	mm MM	~ 50
--	---------	------

Gewicht | Weight | Peso | Poids | Gewicht | Вес

	kg/m ² kr/M ²	~ 40,0
--	---------------------------------------	--------

B
↑

→ A

569138 Cottbus

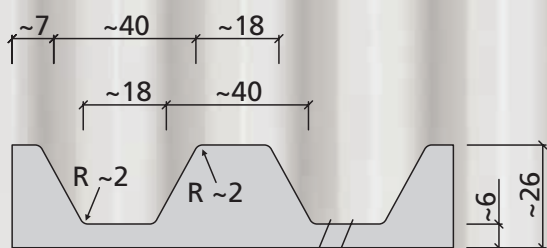

Mattengrößen | Mat sizes | Dimensiones de la estera |
Dimensions des matrices | Matafmetingen | Размеры матриц

A	mm MM	1160
B	mm MM	6000

Mattenstärke | Mat thickness | Espesor de la estera | Epaisseur des matrices
Matdikte | Толщина матриц

mm MM	~ 26
---------	------

Gewicht | Weight | Peso | Poids | Gewicht | Вес

kg/m ² kr/M ²	~ 23,0
---------------------------------------	--------

B
↑

→ A

569137 Dresden

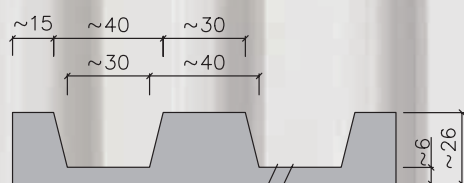

Mattengrößen | Mat sizes | Dimensiones de la estera |
Dimensions des matrices | Matafmetingen | Размери матриц

A	mm MM	1260
B	mm MM	6000

Mattenstärke | Mat thickness | Espesor de la estera | Epaisseur des matrices
Matdikte | Толщина матриц

	mm MM	~ 26
--	---------	------

Gewicht | Weight | Peso | Poids | Gewicht | Вес

	kg/m ² kr/M ²	~ 23,0
--	---------------------------------------	--------



563800 Genf

~10 ~25 ~10

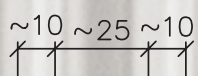

Mattengrößen | Mat sizes | Dimensiones de la estera |
Dimensions des matrices | Matafmetingen | Размеры матриц

A	mm MM	1790	1000
B	mm MM	5800	8200

Mattenstärke | Mat thickness | Espesor de la estera | Epaisseur des matrices
Matdikte | Толщина матриц

	mm MM	~ 18
--	---------	------

Gewicht | Weight | Peso | Poids | Gewicht | Вес

	kg/m ² kr/M ²	~ 19,0
--	---------------------------------------	--------

B
↑

→ A

568800 Gladbeck

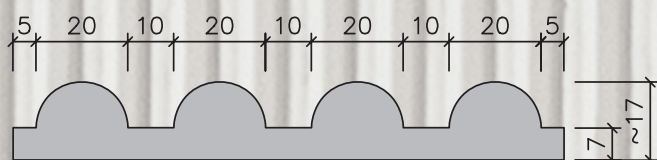

Mattengrößen | Mat sizes | Dimensiones de la estera |
Dimensions des matrices | Matafmetingen | Размеры матриц

A	mm MM	5600
B	mm MM	3900

Mattenstärke | Mat thickness | Espesor de la estera | Epaisseur des matrices
Matdikte | Толщина матриц

	mm MM	~ 17
--	---------	------

Gewicht | Weight | Peso | Poids | Gewicht | Вес

	kg/m ² kr/M ²	~ 17,0
--	---------------------------------------	--------

B
↑
A
→



561500 Gorki

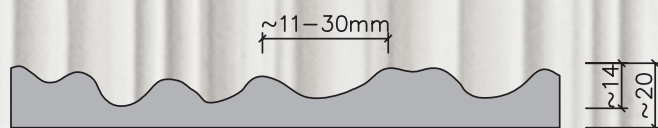

Mattengrößen | Mat sizes | Dimensiones de la estera |
Dimensions des matrices | Matafmetingen | Размерби матриц

A*	mm MM	1200
B	mm MM	7100

Mattenstärke | Mat thickness | Espesor de la estera | Epaisseur des matrices
Matdikte | Толщина матриц

mm | MM ~ 20

Gewicht | Weight | Peso | Poids | Gewicht | Вес

kg/m² | kr/M² ~ 16,0

* Stoßbar nur bei Gesamtmaß 1200 mm | Only joinable with a total size of 1,200 mm | Solo impactable con un tamaño total de 1200 mm | Seulement à joindre à une taille totale de 1200 mm | Alleen schokbaar met een totale afmeting van 1200 mm | Только шок с общим размером 1200 мм

B
↑
A
→

565600 Hamburg

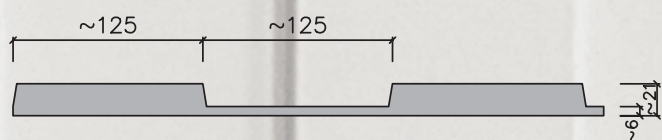

Mattengrößen | Mat sizes | Dimensiones de la estera |
Dimensions des matrices | Matafmetingen | Размеры матриц

A	mm MM	1020
B	mm MM	8000

Mattenstärke | Mat thickness | Espesor de la estera | Epaisseur des matrices
Matdikte | Толщина матриц

mm MM	~ 21
---------	------

Gewicht | Weight | Peso | Poids | Gewicht | Вес

kg/m ² kr/M ²	~ 19,0
---------------------------------------	--------

B
↑

→ A

569139 Jena

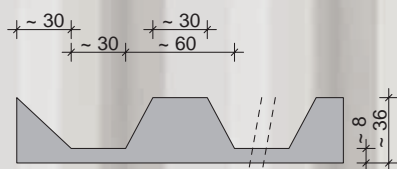

Mattengrößen | Mat sizes | Dimensiones de la estera |
Dimensions des matrices | Matafmetingen | Размери матриц

A	mm MM	990
B	mm MM	4000

Mattenstärke | Mat thickness | Espesor de la estera | Epaisseur des matrices
Matdikte | Толщина матриц

	mm MM	~ 36
--	---------	------

Gewicht | Weight | Peso | Poids | Gewicht | Вес

	kg/m ² kr/M ²	~ 33,0
--	---------------------------------------	--------



566000 Kopenhagen

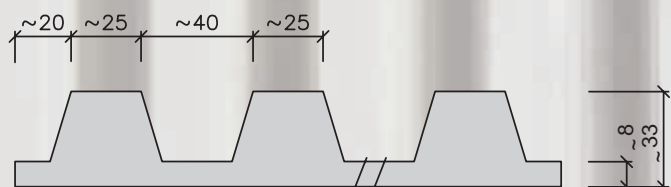

Mattengrößen | Mat sizes | Dimensiones de la estera |
Dimensions des matrices | Matafmetingen | Размеры матриц

A	mm MM	1370
B	mm MM	4000

Mattenstärke | Mat thickness | Espesor de la estera | Epaisseur des matrices
Matdikte | Толщина матриц

mm | MM ~ 33

Gewicht | Weight | Peso | Poids | Gewicht | Вес

kg/m² | kr/M² ~ 30,0

B
↑

→ A

568700 Krefeld

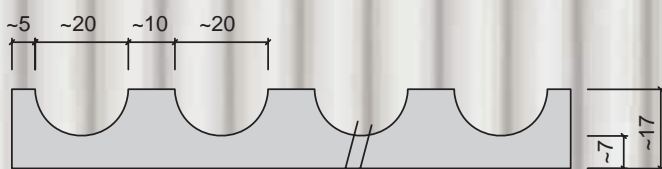

Mattengrößen | Mat sizes | Dimensiones de la estera |
Dimensions des matrices | Matafmetingen | Размеры матриц

A	mm MM	5600
B	mm MM	4000

Mattenstärke | Mat thickness | Espesor de la estera | Epaisseur des matrices
Matdikte | Толщина матриц

	mm MM	~ 17
--	---------	------

Gewicht | Weight | Peso | Poids | Gewicht | Вес

	kg/m ² kr/M ²	~ 16,0
--	---------------------------------------	--------



569136 Leipzig

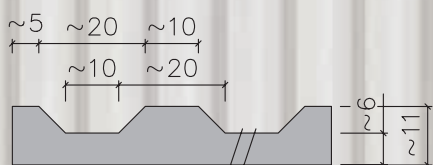

Mattengrößen | Mat sizes | Dimensiones de la estera |
Dimensions des matrices | Matafmetingen | Размеры матриц

A	mm MM	1982
B	mm MM	6000

Mattenstärke | Mat thickness | Espesor de la estera | Epaisseur des matrices
Matdikte | Толщина матриц

	mm MM	~ 11
--	---------	------

Gewicht | Weight | Peso | Poids | Gewicht | Вес

	kg/m ² kr/M ²	~ 14,0
--	---------------------------------------	--------

B
↑

→ A

569159 Linz II

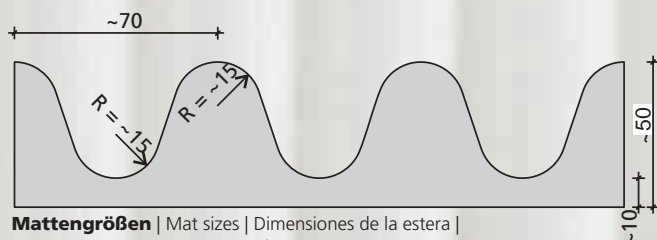

Mattengrößen | Mat sizes | Dimensiones de la estera |
Dimensions des matrices | Matafmetingen | Размеры матриц

A	mm MM	1400
B	mm MM	5600

Mattenstärke | Mat thickness | Espesor de la estera | Epaisseur des matrices
Matdikte | Толщина матриц

	mm MM	~ 50
--	---------	------

Gewicht | Weight | Peso | Poids | Gewicht | Вес

	kg/m ² kr/M ²	~ 42,0
--	---------------------------------------	--------

B
↑
A
→

565200 Luxemburg



Mattengrößen | Mat sizes | Dimensiones de la estera |
Dimensions des matrices | Matafmetingen | Размеры матриц

A	mm MM	1040
B	mm MM	3550

Mattenstärke | Mat thickness | Espesor de la estera | Epaisseur des matrices
Matdikte | Толщина матриц

mm | MM ~ 38

Gewicht | Weight | Peso | Poids | Gewicht | Вес

kg/m² | kr/M² ~ 36,5

B
↑

→ A

561900 Lyon

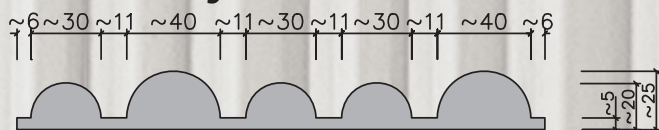

Mattengrößen | Mat sizes | Dimensiones de la estera |
Dimensions des matrices | Matafmetingen | Размеры матриц

A	mm MM	1000
B	mm MM	6000

Mattenstärke | Mat thickness | Espesor de la estera | Epaisseur des matrices
Matdikte | Толщина матриц

mm | MM ~ 25

Gewicht | Weight | Peso | Poids | Gewicht | Вес

kg/m² | kr/M² ~ 20,0

B ↑

→ A



568600 Senden

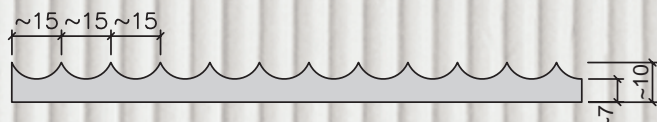

Mattengrößen | Mat sizes | Dimensiones de la estera |
Dimensions des matrices | Matafmetingen | Размеры матриц

A	mm MM	6000
B	mm MM	4000

Mattenstärke | Mat thickness | Espesor de la estera | Epaisseur des matrices
Matdikte | Толщина матриц

	mm MM	~ 10
--	---------	------

Gewicht | Weight | Peso | Poids | Gewicht | Вес

	kg/m ² kr/M ²	~ 15,0
--	---------------------------------------	--------





569170 Sinus

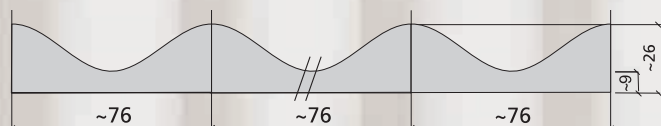

Mattengrößen | Mat sizes | Dimensiones de la estera |
Dimensions des matrices | Matafmetingen | Размери матриц

A	mm MM	2510
B	mm MM	7000

Mattenstärke | Mat thickness | Espesor de la estera | Epaisseur des matrices
Matdikte | Толщина матриц

	mm MM	~ 9
--	---------	-----

Gewicht | Weight | Peso | Poids | Gewicht | Вес

	kg/m ² kr/M ²	~ 22,5
--	---------------------------------------	--------





569160 Tölz

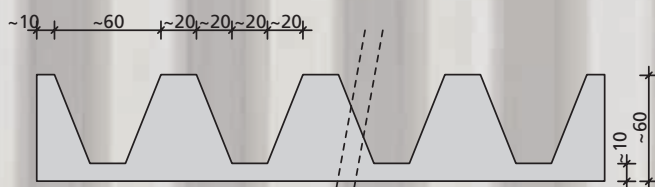

Mattengrößen | Mat sizes | Dimensiones de la estera |
Dimensions des matrices | Matafmetihgen | Размери матриц

A	mm MM	960
B	mm MM	6000

Mattenstärke | Mat thickness | Espesor de la estera | Epaisseur des matrices
Matdikte | Толщина матриц

	mm MM	~ 60
--	---------	------

Gewicht | Weight | Peso | Poids | Gewicht | Вес

	kg/m ² kr/M ²	~ 49,0
--	---------------------------------------	--------

B
↑

→ A

566400 Toronto

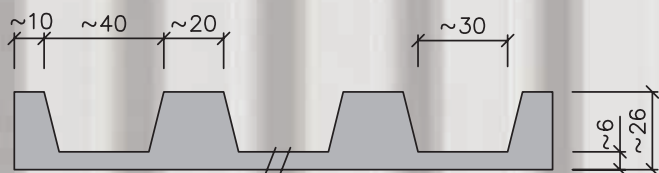

Mattengrößen | Mat sizes | Dimensiones de la estera |
Dimensions des matrices | Matafmetingen | Размеры матриц

A	mm MM	1130
B	mm MM	4910

Mattenstärke | Mat thickness | Espesor de la estera | Epaisseur des matrices
Matdikte | Толщина матриц

	mm MM	~ 26
--	---------	------

Gewicht | Weight | Peso | Poids | Gewicht | Вес

	kg/m ² kr/M ²	~ 20,5
--	---------------------------------------	--------

B
↑

→ A

569133 Warschau

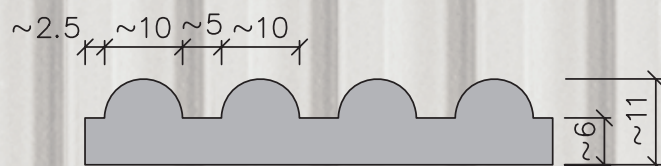

Mattengrößen | Mat sizes | Dimensiones de la estera |
Dimensions des matrices | Matafmetingen | Размери матриц

A	mm MM	1100
B	mm MM	2250

Mattenstärke | Mat thickness | Espesor de la estera | Epaisseur des matrices
Matdikte | Толщина матриц

	mm MM	~ 11
--	---------	------

Gewicht | Weight | Peso | Poids | Gewicht | Вес

	kg/m ² kr/M ²	~ 14,0
--	---------------------------------------	--------



2017



Mattengrößen | Mat sizes | Dimensiones de la estera |
Dimensions des matrices | Matafmetingen | Размерби матриц

A	mm MM	455
B	mm MM	255

Mattenstärke | Mat thickness | Espesor de la estera | Epaisseur des matrices
Matdike | Толщина матриц

	mm MM	~ 20
--	---------	------

Gewicht | Weight | Peso | Poids | Gewicht | Bec

	kg/m ² kr/M ²	~ 2,2
--	---------------------------------------	-------

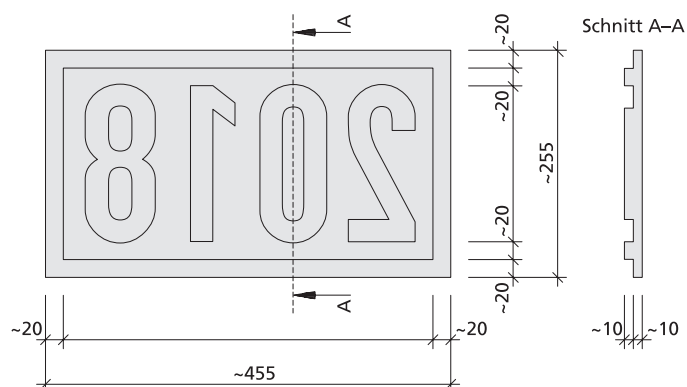

Nach Richtzeichnung – 1 Jahr –
des Bund/Länder-Fachausschusses
Brücken- und Ingenieurbau
BMV Abt. StB



DyD

Calle Calibre 45
28400 Villalba (Madrid)
Tel: +34 915 51 79 54 / 902 10 40 56
Correo electrónico: info@d-y-d.com
Web: www.d-y-d.com